

# SCX SERIES

Commercial Lighting

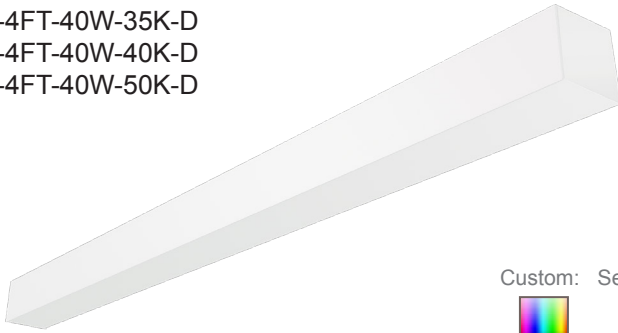

- SCX-4FT-40W-30K-D
- SCX-4FT-40W-35K-D
- SCX-4FT-40W-40K-D
- SCX-4FT-40W-50K-D



Custom: Selection:



Customer Name: \_\_\_\_\_  
 Project Name: \_\_\_\_\_  
 Note: \_\_\_\_\_ | Type: \_\_\_\_\_

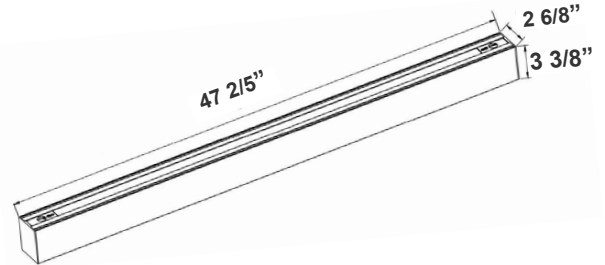

47 2/5" (L) x 2 6/8" (W) x 3 3/8" (H)

The SCX series offers the best and the most comprehensive selection for linear lighting. The various available lengths and widths allow the creation of the desired shape to elevate the areas aesthetics to a unique and modern look while providing an impressive illumination for the occupants. Ideal for, retail locations, offices, lobbies, conference rooms, reception areas, hallways, educational facilities, hotels, and restaurants. FEATURES: Superior Architectural Look Energy-efficient: Low Wattage Consumption & High Lumen Output Easier Wire Management & Install Variety of Mounting Options Multi Color Temperature (Selectable Switch Inside Fixture) Variety Of Factory Customizations Available

## Features

- LED Superior Architectural Lights
- Seamless Linkable Linear Lighting System
- Opal Polycarbonate Lens-Direct (DOWN) Lighting
- Optional Recessed & Wall Mounting Kits Available
- 50,000 Hours Rated Life
- 5-Year Warranty
- Lens Type: Opal Polycarbonate Lens
- Optional Louver Version Lens Available

## Technical Specifications

### Electrical:

- Voltage: 120-277VAC 50/60Hz
- Wattage: 40W
- Power Factor: >0.95

### Mechanical:

- Low Profile Modern Design
- Aluminum Housing With Matte White Finish
- Custom Colors Available
- Lens Snaps into Housing
- Make Different Connections Via T/L/X Joints on Both Ends
- Mounting Options: Surface, Suspended, Wall, Recessed
- IP Rating: IP54
- Operating Temperature: -13°F~104°F

### Lighting:

- Dimmable: 0~10V Dimming
- Total Lumens: 4480LM/4600LM/4720LM/4840LM
- Color Temperatures: 3000K/3500K/4000K /5000K
- Color Rendering Index: CRI ≥ 80
- Up Light Option Available
- Beam Angle: 104.8°(H) x 100.5°(V)

### Applications:

- Ideal for offices, hotels, corridors, saloons, libraries, meeting rooms, conference halls, and the best solution for modern lighting solutions
- It can be used in any indoor applications

### Other Models:

- 20W | 2240LM | SCX-2FT-20W-30K-D
- 30W | 3360LM | SCX-3FT-30W-30K-D
- 60W | 6720LM | SCX-6FT-60W-30K-D
- 80W | 8960LM | SCX-8FT-80W-30K-D
- 20W | 2300LM | SCX-2FT-20W-35K-D
- 30W | 3450LM | SCX-3FT-30W-35K-D
- 60W | 6900LM | SCX-6FT-60W-35K-D
- 80W | 9200LM | SCX-8FT-80W-35K-D
- 20W | 2360LM | SCX-2FT-20W-40K-D
- 30W | 3540LM | SCX-3FT-30W-40K-D
- 60W | 7080LM | SCX-6FT-60W-40K-D
- 80W | 9440LM | SCX-8FT-80W-40K-D
- 20W | 2420LM | SCX-2FT-20W-50K-D
- 30W | 3630LM | SCX-3FT-30W-50K-D
- 60W | 7260LM | SCX-6FT-60W-50K-D
- 80W | 9680LM | SCX-8FT-80W-50K-D



Phone: (877) 805-2252 | Fax: (877) 805-2252  
www.westgatemfg.com |



## Photometrics: SCX-4FT

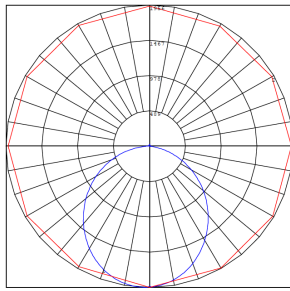
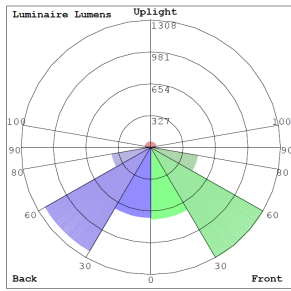

BUD Rating: B2-U3-G1

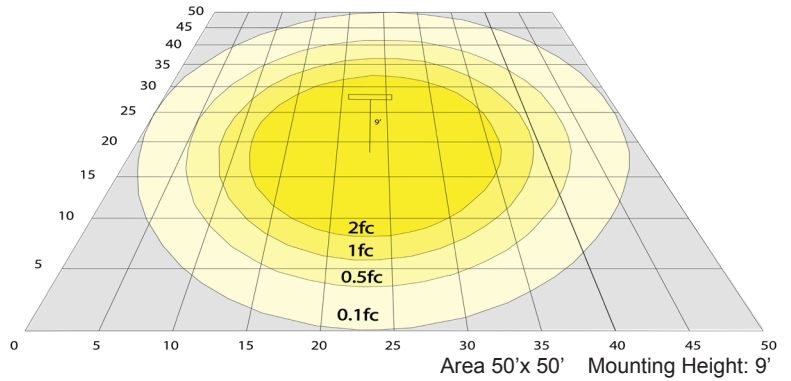

Area 50'x 50' Mounting Height: 9'

## Other Views:



Front View

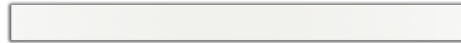

Side View



Back View

## Performance Table: SCX-4FT

MODEL NO.	Wattage	Voltage	Lumens	Color Temp.	BUG Rating	LPW
SCX-4FT-40W-30K-D	40W	120~277V	4480LM	3000K	B2-U3-G1	112
SCX-4FT-40W-35K-D	40W	120~277V	4600LM	3500K	B2-U3-G1	115
SCX-4FT-40W-40K-D	40W	120~277V	4720LM	4000K	B2-U3-G1	118
SCX-4FT-40W-50K-D	40W	120~277V	4840LM	5000K	B2-U3-G1	121

## Sample Ordering

Model	Size	Wattage	Color Temp.	Feature
SCX	4FT	40W		D

30K = 3000K  
35K = 3500K  
40K = 4000K  
50K = 5000K

## Accessories:

Blank = No Option For Accessories

SCL-CS1-6FT = ADJ. 6FT 1/16in SINGLE SUSPENSION CANOPY SET WITH KEYHOLE END CONNECTOR, NON-POWER SIDE

SCL-CS1P-6FT = ADJ. 6FT 1/16in SINGLE SUSPENSION CANOPY SET WITH KEYHOLE END CONNECTOR, POWER SIDE WITH SJTW18/5 WHITE CORD

SCL-CS1P-6FT-NC = ADJ. 6FT 1/16in SINGLE SUSPENSION CANOPY SET WITH KEYHOLE END CONNECTOR

SCL-GS10 = ADJ. 10FT 1/16in DOUBLE SUSPENSION CABLE WITH SINGLE KEYHOLE CONN., LOOP GRIPPER ON TOP

SCL-GS20 = ADJ. 20FT 1/16in DOUBLE SUSPENSION CABLE WITH SINGLE KEYHOLE CONN., LOOP GRIPPER ON TOP

SCL-6FT-SJTW18/5 = 6ft White Cord, SJTW 18 AWG 5-Conductor (Black, White, Green + Purple & Gray for 0-10V Dimming)

SCL-6FT-SJTW18/5-100FT = 100ft Roll of White Cord, SJTW 18 AWG 5-Conductor (Black, White, Green + Purple & Gray for 0-10V Dimming)

SCL-6FT-SJTW18/5-100FT-BK = 100ft Roll of Black Cord, SJTW 18 AWG 5-Conductor (Black, White, Green + Purple & Gray for 0-10V Dimming)

SCL-6FT-SJTW18/6-100FT = 100ft Roll of Black Cord, SJTW 18 AWG 6-Conductor (Black, White, Green + Purple & Gray for 0-10V Dimming + Red for Backup Inverter)

SCL-AH = Heavy-Duty Auxiliary Hook for Up To 1/16" Aircraft Cable

SCL-ASC-500FT = 1/16" 500 ft. Steel Aircraft Cable Suspension

\* More Mounting Options Refer to page 4

## Factory-Installed Options:

Blank = No Option For Accessories

OPT-HBC-125BS-WH = 10FT, 15A, 125V, 18/3 STR, WHT

\* More Factory-Installed Options Refer to page 6

## SUSPENDED MOUNTING ACCESSORIES (NOT INCLUDED)



SCL-CS1-6FT SCL-CS1P-6FT SCL-CS1P-6FT-NC SCL-GS10 SCL-GS20



SCL-6FT-SJTW18/5-100FT



SCL-6FT-SJTW18/5-100FT-BK



SCL-ASC-500FT



SCL-AH



SCL-ASC-500FT



SCL-6FT-SJTW18/5

## FACTORY-INSTALLED OPTIONS:



OPT-HBC-125BS-WH

## Example:

- SCX-4FT-40W-40K-D (For SCX 40W 4000K fixture 120-277V)
- SCX-4FT-40W-40K-D OPT-HBC-125BS-WH (For SCX 40W 4000K fixture 120-277V) (10FT, 15A, 125V, 18/3 STR, WHT)



# MOUNTING AND MODULES OPTIONS:

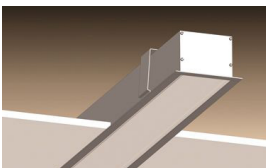

Recessed Mounted  
(Flanged)



Surface Mounted



Wall Mounted



Suspended



T-Bar Installation

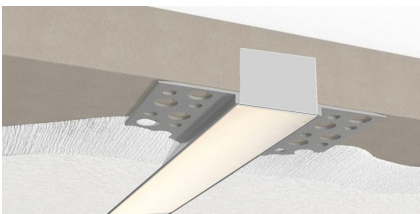

Flangless Recessed Mounted  
(Mud-In)



Louver Kit Option

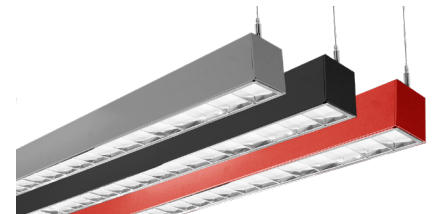

Color of Your Choice

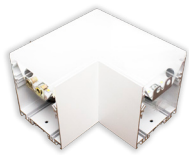

L Module  
(page 7)

- SCX-L-30K
- SCX-L-35K
- SCX-L-40K
- SCX-L-50K



T Module  
(page 7)

- SCX-T-30K
- SCX-T-35K
- SCX-T-40K
- SCX-T-50K

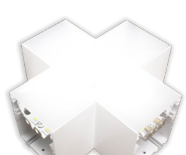

X Module  
(page 8)

- SCX-X-30K
- SCX-X-35K
- SCX-X-40K
- SCX-X-50K



Inside Corner Module  
(page 8)

- SCX-IC-30K
- SCX-IC-35K
- SCX-IC-40K
- SCX-IC-50K



120° Corner Module  
(page 9)

- SCX-C120-30K
- SCX-C120-35K
- SCX-C120-40K
- SCX-C120-50K



Suspension Rod Kit

- SCL-RS-12 12"
- SCL-RS-18 18"
- SCL-RS-24 24"
- SCL-RS-36 36"
- SCL-RS-48 48"

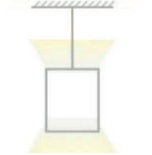

Up Light Option

- 3000K
- 3500K
- 4000K
- 5000K
- Blue
- Green



## MOUNTING OPTIONS:

### FLANGLSS RECESSED INSTALLATION IN WOOD CEILING

No additional accessories required.

Make recessed preparations by installing a horizontal plank of wood on top of the wood ceiling at a recessed height of 3 3/8".

Screw and anchor kit provided with each fixture can be used to fasten the top of the fixture to the wood plank through the holes on top of the fixture.

You can also install vertical wood boards on top of the ceiling at the edge of the opening and open the fixture and put screws through the side of the fixture housing to fasten it to the wood boards.



### SUSPENSION ROD KITS (SET OF 2)

Model	SIZE
SCL-RS-12	12 IN
SCL-RS-18	18 IN
SCL-RS-24	24 IN
SCL-RS-36	36 IN
SCL-RS-48	48 IN

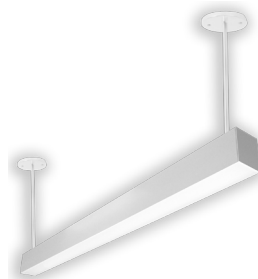

### WALL MOUNTING

Model	DESCRIPTION
OPT-SCX-WM-4FT	Install this optional wall mounting brackets on the back of the fixture. Connection cables will enter the fixture through one of these wall-mounting brackets. On your purchase order, please specify the position of where your wire entry from the wall.

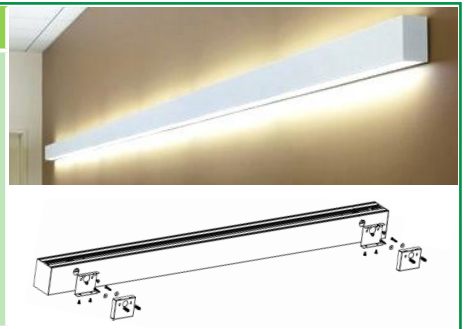

### WALL MOUNTING

Model	DESCRIPTION
OPT-SCX-WMA-4FT	Add this option to the fixture, and wall mounting arms with a wall canopy will be installed on the back of the fixture. The length of each arm is 5". Connection cables will enter the fixture through one of the arms. On your purchase order, specify the position of your wire entry from the wall, and the arm will be installed on the back accordingly.



### RECESSED MOUNT WITH FLANGE

Model	DESCRIPTION
OPT-SCX-FMR-4FT	Order this option and the fixture will be equipped with a 1/2" wide flange on four sides. Advanced design toggle-style brackets will also be provided, to adjust and hold the fixture against drywall or other hard ceilings from the top. When linking to another fixture or corner module, call us or send a copy of your plan along with your PO, and flanges will be removed on those ends that need to make a seamless connection.

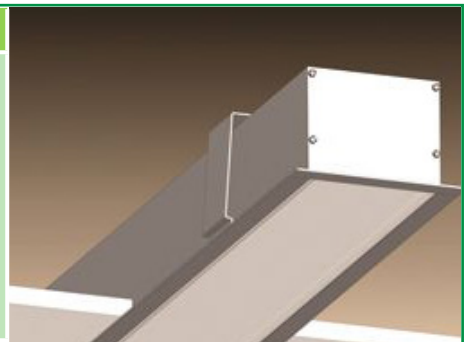

## LINKING

Model	DESCRIPTION
OPT-SCX-LINKWIRING	Fixtures are equipped with pre-installed linking brackets and accessories and only need to be wired together. To receive a fixture prewired for linking, order the option below for each link to another fixture or a corner module.

## FLANGELESS RECESS MOUNT IN DRYWALL (MUD-IN)

Model	DESCRIPTION
OPT-SCX-MIF-4FT	Order this option and the fixture will be equipped with mud-in brackets on all four sides, mounted at 1/16" from the lens surface (specify if other spacing is needed). Advanced design toggle-style brackets will also be provided, to adjust and hold the fixture against the drywall ceiling from the top. When linking to another fixture or corner fixture module call us or send a copy of your plan along with your PO and flanges will be removed on those end that needs to make a seamless connection.
OPT-SCX-MIF-L	This is a L Module option.
OPT-SCX-MIF-T	This is a T Module option.
OPT-SCX-MIF-X	This is a X Module option.
OPT-SCX-MIF-IC	This is a Inside Corner Module option.

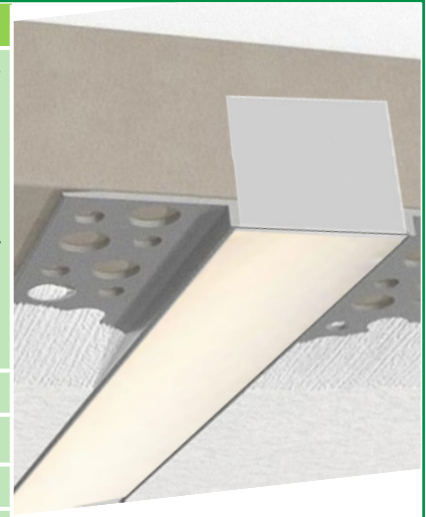

## T-BAR INSTALLATION

Model	DESCRIPTION
OPT-SCX-TBAR-4FT	Add this option and 1/2" wide flanges will be installed on the two long sides of the fixture. The two ends of the fixture will fall onto the T-bar grids and will be supported this way. The T-bar tiles on the two sides of the fixture must be cut to allow for the width of the fixture. The tile will fall onto and be supported by the flanges on both sides of the fixture. If you plan to support the fixture by the grids on three sides and tile on one side, call us or specify on your PO, and flange will be installed only on one side of the fixture. To provide safety and support from the beams above the T-bar ceiling order 10ft or 20ft aircraft suspension kits below.
SCL-GS10	Adjustable 1/16" 10ft suspension kit with loop gripper & toggle ends hold up to 70 lbs load.
SCL-GS20	Adjustable 1/16" 20ft suspension kit with loop gripper & toggle ends hold up to 70 lbs load.
OPT-FWH-63	This is a 6FT 3-Wire Whip option.
OPT-FWH-65	This is a 6FT 5-Wire Whip option.
OPT-FWH-66	This is a 6FT 6-Wire Whip option.



## SURFACE MOUNTING

No additional accessories required. Screw and anchor kit provided with each fixture can be used to fasten the fixture directly to the hard surface through the holes on top of the fixture.

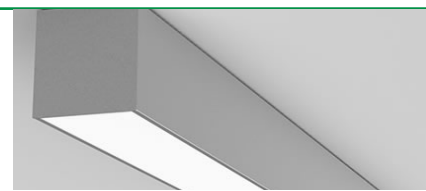

## LIGHTS SCX FLEXIBLE LENS ROLL 25FT OR 100FT

Model	SIZE	DESCRIPTION	
SCX-FLEXLENS-25FT	25FT	Flex lenses can be cut to different lengths, enabling precise customization according to the installation area. This allows for a seamless fit, reducing gaps or visible transitions between different sections of the SCX lights	
SCX-FLEXLENS-100FT	100FT		

## FACTORY-INSTALLED OPTIONS:

### LOUVER VERSION

Model	DESCRIPTION	LUMENS @ 4000K	SIZE	
OPT-SCX-LUV-4FT	This Louver option includes lens inside.	4320LM	4FT	

### COLOR OF YOUR CHOICE

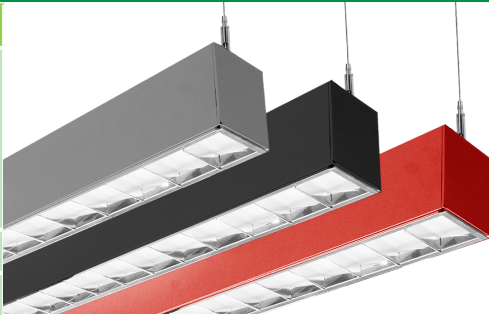
Model	DESCRIPTION	
OPT-SCX-CLR-4FT	Add this option and specify your desired color on your purchase order or provide a swatch to match. For painted flanged fixture or optional rod, mounting set please also add the relevant option below for each fixture.	
OPT-SCX-CLR-FRM	This is a painted flanges option.	
OPT-SCX-CLR-RODSET	This is a painted rod set option.	

### EMERGENCY BATTERY BACKUP

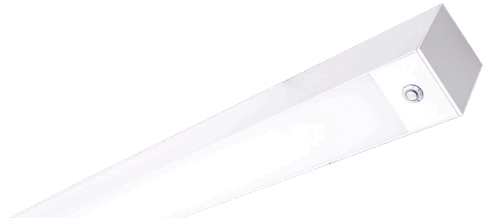
Model	DESCRIPTION	
OPT-EM-CM1INT	This is an option for a 90-minute backup battery installation. If you need to order this series for the fixture, please have your purchase order ready and call us or specify on the order which fixture to install this option and the test button.	

### BI-LEVEL MOTION SENSOR

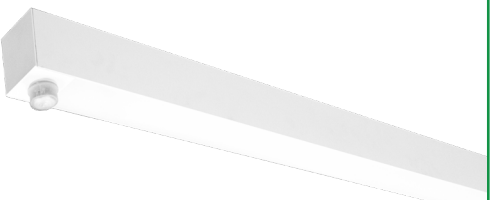
Model	DESCRIPTION	
OPT-SCX-SEN2US	This option installs an advanced motion sensor that will turn the lights on when the area is occupied. When the area is cleared, after a preset hold time of 5 sec or more the lights are dimmed to a standby level of 30% or more. If still no motion is detected, after the standby period, the light is turned off. All setting is programmable with a remote control.	
OPT-WEC-3RC	This is an optional remote control for sensor.	
OPT-SEN-SCX-2MRLV-5	This is a programmable microwave Bi-Level sensor.	
OPT-SEN-2US-DAYLIGHT	It is an ultrasonic Bi-Level Dimming Daylight sensor option for internal installation inside the fixture. (Remote not needed)	



## INDIRECT (UP) LIGHTING

Model	WATTS	LUMENS	COLOR TEMP	SIZE
OPT-SCX-ULM-4FT-16W-30K	16W	1600LM	3000K 3500K 4000K 5000K	4FT
OPT-SCX-ULM-4FT-16W-35K		1648LM		
OPT-SCX-ULM-4FT-16W-40K		1680LM		
OPT-SCX-ULM-4FT-16W-50K		1728LM		
OPT-SCX-ULM-BU	Indirect (up) light with blue color			
OPT-SCX-ULM-GR	Indirect (up) light with green color			



## DEDICATED WIRING FOR UPLIGHT CONTROL

Model	DESCRIPTION			
OPT-SCX-UCL-4FT-MCT4	Dedicated Wiring For Uplight Control By Installing A Separate Electrical Circuit And Compatible Driver For Uplighting. This Ensures Independent Control And Power Management. A Driver Regulates The Voltage And Current Supplied To The Uplights, Allowing For Precise Brightness And Color Control, Often Through A Dimmer Or automation System.			
	WATTS	LUMENS	COLOR TEMP	SIZE
	16W	1600LM	3000K 3500K 4000K 5000K	4FT
		1648LM		
		1680LM		
1728LM				

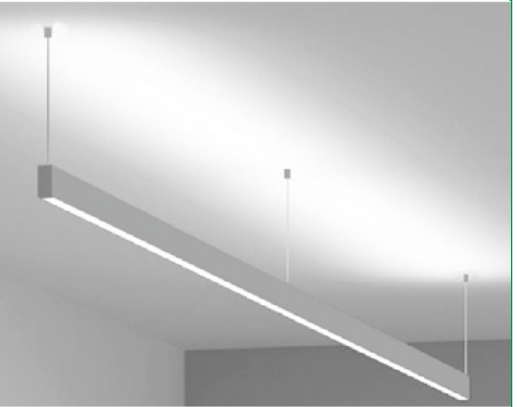

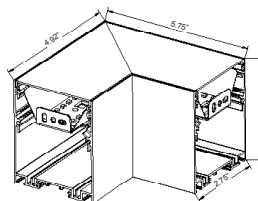
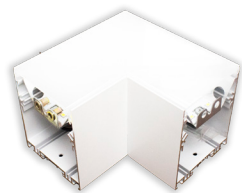

## CORNER FIXTURE MODULES:

### Built-in LED Modules

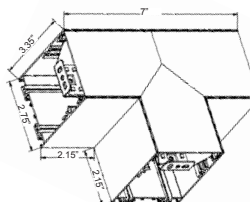

Model	JOINT TYPE	LUMENS	COLOR TEMP	DIMENSION
SCX-L-30K	L	508LM	3000K	5.75" X 5.75" X 3.35" X 2.75"
SCX-L-35K	L	575LM	3500K	5.75" X 5.75" X 3.35" X 2.75"
SCX-L-40K	L	616LM	4000K	5.75" X 5.75" X 3.35" X 2.75"
SCX-L-50K	L	660LM	5000K	5.75" X 5.75" X 3.35" X 2.75"



Model	JOINT TYPE	LUMENS	COLOR TEMP	DIMENSION
SCX-T-30K	T	629LM	3000K	7" X 3.35" X 2.75" X 2.15" X 2.15"
SCX-T-35K	T	726LM	3500K	7" X 3.35" X 2.75" X 2.15" X 2.15"
SCX-T-40K	T	787LM	4000K	7" X 3.35" X 2.75" X 2.15" X 2.15"
SCX-T-50K	T	854LM	5000K	7" X 3.35" X 2.75" X 2.15" X 2.15"

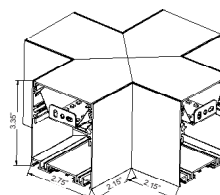
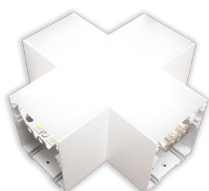

Model	JOINT TYPE	LUMENS	COLOR TEMP	DIMENSION
SCX-X-30K	X	733LM	3000K	3.35" X 2.75" X 2.15" X 2.15"
SCX-X-35K	X	863LM	3500K	3.35" X 2.75" X 2.15" X 2.15"
SCX-X-40K	X	944LM	4000K	3.35" X 2.75" X 2.15" X 2.15"
SCX-X-50K	X	1037LM	5000K	3.35" X 2.75" X 2.15" X 2.15"





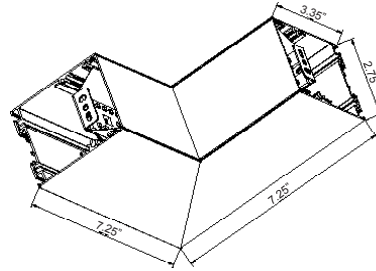

Model	JOINT TYPE	LUMENS	COLOR TEMP	DIMENSION
SCX-IC-30K	INSIDE CORNER	629LM	3000K	7.25" X 7.25" X 3.35" X 2.75"
SCX-IC-35K	INSIDE CORNER	726LM	3500K	7.25" X 7.25" X 3.35" X 2.75"
SCX-IC-40K	INSIDE CORNER	787LM	4000K	7.25" X 7.25" X 3.35" X 2.75"
SCX-IC-50K	INSIDE CORNER	854LM	5000K	7.25" X 7.25" X 3.35" X 2.75"

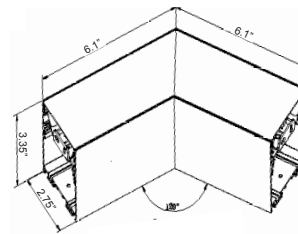

Model	JOINT TYPE	LUMENS	COLOR TEMP	DIMENSION
SCX-C120-30K	120° CORNER	508LM	3000K	6.1" X 6.1" X 3.35" X 2.75"
SCX-C120-35K	120° CORNER	575LM	3500K	6.1" X 6.1" X 3.35" X 2.75"
SCX-C120-40K	120° CORNER	616LM	4000K	6.1" X 6.1" X 3.35" X 2.75"
SCX-C120-50K	120° CORNER	660LM	5000K	6.1" X 6.1" X 3.35" X 2.75"

### WOOD TRIMS

Model	DESCRIPTION
OPT-SCX-WK01-4FT-MAPLE	4FT MAPLE FINISH
OPT-SCX-WK01-4FT-WALNUT	4FT WALNUT FINISH
OPT-SCX-WK01-4FT-FREOAK	4FT FRENCH OAK FINISH
OPT-SCX-WK01-4FT-EBONY	4FT EBONY FINISH



	MAPLE		WALNUT
	FRENCH OAK		EBONY



**COLOR CHART:** \* Choose from one of our Premium Colors with no set-up fee.

**Gloss:**



SILVER METALLIC  
70 GLOSS  
T357-GR105



SILVER METALLIC  
30 GLOSS  
T353-GR06



DARK RED 90  
GLOSS  
P009-RD02



INTERNATIONAL  
ORANGE 90  
GLOSS  
T009-OG26



SAFETY ORANGE  
90 GLOSS  
T009-OG01



YELLOW 90  
GLOSS  
T009-YL14



YELLOW 90  
GLOSS  
T009-YL01

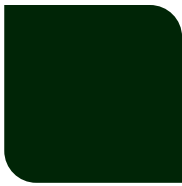

TRAFFIC GREEN  
70 GLOSS  
T007-GN16

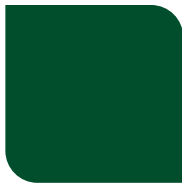

GREEN 70 GLOSS  
T007-GN13



GREEN 60 GLOSS  
C006-GN03



BLUE 90 GLOSS  
T009-BL01



DARK BLUE 80  
GLOSS  
T008-BL20

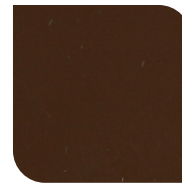

RAL 8028 TERRA  
BROWN 90 GLOSS  
C209-BR358

**Hammer:**



WHITE HAMMER  
T013-WH09



BEIGE HAMMER  
T013-BG38



GREY HAMMER  
C013-GR08

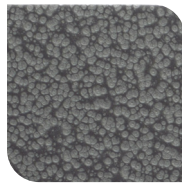

SILVER  
HAMMERTONE  
T064-GR05



BLACK HAMMER  
T013-BK62



RED HAMMER  
T013-RD15



GREEN HAMMER  
T013-GN220

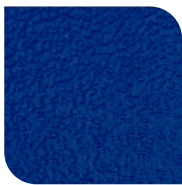

BLUE HAMMER  
T013-BL468



BRONZE HAMMER  
T012-BR161

**Texture:**



WHITE TEXTURE  
C031-WH120



FLINT GRAY  
TEXTURE  
T243-GR522



BLACK TEXTURE  
C241-BK109



RED TEXTURE  
T241-RD129



BLUE TEXTURE  
C241-BL544



OIL RUBBED  
BRONZE TEXTURE  
T291-BR251

**Vein:**



BLACK/WHITE  
VEIN  
T075-WH34



SILVER VEIN  
T375-BK26

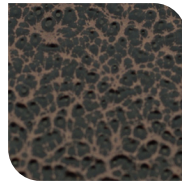

COPPER VEIN  
EXTERIOR  
T075-BK211



GOLD VEIN  
T375-BK10



COPPER VEIN  
T375-BK07

